

Science, Technology and Society - An authentic exploration on IR thermometers application in schools

Isaac Pak Hoi TSE

Faculty of Education, University of Hong Kong

Winston Kwok Kuen LEUNG and Shing Yi CHAN

Po Leung Kuk Yao Ling Sun College, Hong Kong

Email: isaactse@hkusua.hku.hk and gwinston@netvigatior.com

Received 4 June, 2004

Revised 3 August, 2004

Contents

- [Abstract](#)
 - [Introduction](#)
 - [Aims of Science Education in Hong Kong](#)
 - [The Extra-curricular Situation](#)
 - [The Problems of using IR non-contact thermometers](#)
 - [Our Sequence of Investigations](#)
 - [Scope for Setting Different Project Learning Scenarios](#)
 - [Conclusion](#)
 - [References](#)
 - [Report](#)
-

Abstract

"Science, Technology and Society" was identified an essential strand in the new Science Education curriculum guide. Shortly after the SARS threat to Hong Kong technical dealers introduced Infrared non-contact thermometers as a solution for schools to measure body temperature for a large number of students in a short period of time before they enter the school building for another new daily routine. We found that the devices work erratically beyond our expectation and we worked scientifically

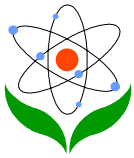

and systematically to understand their operation. We then realized that this exploration could be converted into an open-ended learning opportunity for school students to appreciate the connections between scientific and rational deductions, use of technology, critical evaluation of technical products and the appropriate application of technological products to serve the needs of the society.

Introduction

The strand "Science, Technology and Society" has been identified as a vital link to justify the importance of science education in a modern knowledge, information and technology driven society. There are at least two evident purposes of learning science that could be transferred to other disciplines:

1. to acquire skills for informed and data-driven decision making.
2. to bridge rational thinking between scientific knowledge, development of technology and application in society.

Within this ambit, critical thinking, realization of prospective projections and constraints, systematic problem solving, creative model for understanding, etc. are the successful products. Traditional science is particularly good at reducing the problem space to simple linear relationships that could be expressed in mathematical equations. New science deal with complexity (Wheatley, 1999) and dynamical systems; something too complicated for linear equations and is better expressed in the form of landscapes and metaphors. Unfortunately, in the real world, most students learn traditional science primarily for good grades in public examinations and live intuitively independent of their scientific training.

Real world is always complex. Layers of cause and effects are embedded and intertwined in the details. Words and promises in advertisements of the commercial world could be deceptive. Myths and traditional thinking mask rational scientific thoughts. As a result, real life situations often lead to surprises. That is why there is always room for the next generation to explore. Those who get themselves equipped fast gain more in the new information age.

The deadly viral pneumonia Severe Acute Respiratory Syndrome (SARS) epidemic attacked Hong Kong by surprise in 2003, followed by another deadly H5N1 Avian flu viral epidemics. Early detection and isolation of patients with fever was deemed an

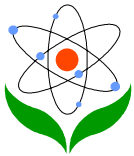

effective measure in preventing the spread of these epidemic diseases. Different solutions for body temperature measurement were marketed in a shrift bloom within a month. We have been busy screening new products and establishing new procedures in combat with the disease. We have forgotten about turning this into an open ended learning opportunity to train students on the goal of applying science and technology. Technology application has to fit the needs of the society. We were misled by fads until we realized the shortcoming of the products we adopted.

Aims of Science Education in Hong Kong

The school science curriculum was reviewed in early 2000s and a new "Key Learning Area Curriculum Guide (Primary 1 to Secondary 3): Science Education" was published (Curriculum Development Council, 2002) for implementation in schools of Hong Kong. School science education is to provide learning experiences through which students acquire scientific literacy, "to develop the necessary scientific knowledge and understanding, process skills, values and attitudes, for their personal development, for participating actively in a dynamically changing society, and for contributing towards a scientific and technological world". (p.19)

Aims of science education were set as to:

1. develop curiosity and interest in science;
2. develop the ability to inquire and solve problems;
3. acquire basic scientific knowledge and concepts for living in and contributing to a scientific and technological world;
4. recognize the usefulness and limitations of science and the interconnections between science, technology and society and to develop an attitude of responsible citizenship, including respect for the environment and commitment to the wise use of resources;
5. become familiar with the language of science and be equipped with the skills to communicate ideas in science-related contexts;
6. appreciate and understand the evolutionary nature of scientific knowledge;
7. attain personal growth through studying science; and
8. be prepared for further studies or enter careers in scientific and technological fields. (ibid. p.17-18)

This forms the basis for further development of the Curriculum Guide for Senior

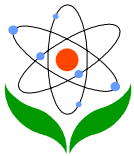

Secondary science curriculum to be furnished in 2004.

The Extra-curricular Situation

Schools were compelled to look for one solution and then another in the rush to combat SARS and H5N1 Avian Flu virus etc. since March 2003. Oral thermometers were out of the question in face of the time requirement for each test and the vast number of students entering the school gate every morning within a short twenty minutes. The more efficient InfraRed (IR) ear detection thermometers were challenged for the possible alternative threat of dermal contagious diseases. Non-contact IR thermometer sounds the perfect solution to tackle the demand for quick measurement of body temperature every morning. Technical sales agents rush to search for such industrial device, prepared attractive pamphlets within short period of time and began their launch for promotion to schools in the frenzy to look for an efficient solution.

However after a fairly short initial application of our new tools, we discovered that the IR non-contact thermometers sold to schools were far from being foolproof. We started to investigate the source of random errors and by serendipity we discovered that this could be converted into a flexible project-based learning opportunity at all levels in different ways in a secondary school. This article aims to facilitate a full understanding on the limitation of application of IR non-contact thermometer devices and then explore possible scenario for students-centered learning in schools.

The Problems of using IR non-contact thermometers

The common practice for schools is to check students' body temperature at the school gate. The school gate is the boundary between open space and the enclosed environment. Our purpose is to prevent sick students from entering crowded classrooms. The school gate area is susceptible to the influence of natural breeze, humidity and variations in temperature of the surroundings. Students may also show a higher body temperature after walking, or running to school.

To our surprise, operators of different hand-held IR non-contact thermometer devices reported that temperature reading dropped beyond explanations. Early in the morning, the readings on the IR thermometer were near normal (38.5°C). Then readings

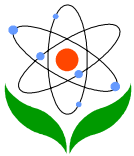

dropped consistently after half an hour of operation. Indications were below normal for all students trusted to have a normal temperature. This phenomenon persisted every morning. Moreover, different IR thermometer models varied in different ways.

School administration can be held accountable if the fatal SARS or H5N1 Avian flu is transmitted in the classroom environment due to the school's failure to screen out the sick students. We began to conduct a systematic scientific investigation. This proved to be a continuous learning process for both our students and staffs. We realized our scientific deductions are tentative no matter how many times we reflected over our findings. Our empirical theory was always new hypothesis about the most appropriate application of the tools.

Our Sequence of Investigations

With any artificial electronic device, the first thing scientists trained was to learn about zero adjustment and calibration. We demand the device to be consistent in its reading within a known range of detection. If it functions but fails to be consistent, or if its readings drop consistently, we check battery voltage input. The simplest remedy is to change for new batteries. If these were not good enough, we suspect consistency of user in applying these handheld devices.

With these tentative hypotheses in mind, we tackled suspected reasons of fluctuations, which include:

- (1) Battery voltage drop after current consumption has reached a certain level
- (2) Low quality and/or poor stability of the device
- (3) Ambient temperature fluctuations where the device is being used
- (4) Skill of the operators holding these handheld devices
- (5) Specifications requirement of the device not observed when being used

We put forward our study in the report in web html format in order to be as reader friendly as we could. Web browsers offer a convenient "PREVIOUS" button within the "Standard Buttons" tool bar at the top left corner of the current window for quick return to where the reader clicks a hyper-link. Press this button instead of scrolling up and down with mouse keys. We anticipate including senior secondary students as our potential readers too. We falsified hypotheses 1 and 2 using the Data-Logger.

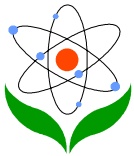

Using a 3Kg cast iron block as proxy of a human head, our results ([Fig. 1-3](#)) confirmed that the IR non-contact thermometer devices were calibrated to acceptable standard, which is the linear readings displayed between 20°C and 55°C ([Section 1](#) of the html report).

In [Section 2](#) of the html report, we proved that there is no significant difference in performance by using a fresh battery or a spent one. Voltage drop was not a burning issue.

In [Section 3](#) of the html report, we disproved the possibility of internal warming of the thermometer or any other internal fault that might cause declining stability of the device while operating a prolonged time beyond the session it was originally designed.

The repeated tests in [Section 4](#) of the html report confirmed that cool air blowing towards the target of temperature measurement ([Fig. 4](#)) or even blowing hot warm air towards the target ([Fig. 5-7](#)) do not significantly affect the performance of the IR non-contact thermometer.

Investigation on the physical dimension of the artificial device comes to a temporary end. The next target of suspect would be human factors, namely, the handgrip and attitudinal variations ([Fig. 8](#)).

Our results in [Section 5](#) provide clues for possible source of deviations, focused aiming and casual targeting of the hand held device make some difference despite an undetectable tilt of 9 degree in perspectives ([Fig. 9](#)). The print on the hand-held device ([Pic C](#)) then arrested our attention. The invisible IR emission should obey the Inverse Square Law, but not the visible laser beam for focusing.

The operation manual stipulated that a "Distance to Spot Ratio" requirement should be observed; and that the detection area must be larger than the required spot size stipulated in order to get correct readings. This has been ignored. Biologists among us then recalled that surface temperature distribution of the forehead is not uniform as shown in the thermographic image ([Fig. 11](#)). The reading shown on display offers the AVERAGE temperature of the detected region. If the object to be measured cannot fill up the Field of View for the detection spot (Positions S2, S3, S4 and S5 of [Fig. 9](#)),

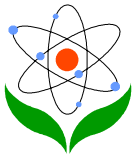

unpredictable errors easily occur ([Pic D](#)). For example, if the diameter of the spot with consistent body temperature on human forehead was only about 40mm, the device should thus be placed at about 320mm away from the detected region all the time in accordance with the specification requirement of the model used.

By inspecting another similar product in the market, we learned further that we could easily be fooled by our own mindset towards known range of output. Product capability claimed by the advertisers and local sales agents could be totally different from the technical advice of the manufacturers. Maybe we have discovered the need for a purpose built, speedy, handy and portable technical device to measure human forehead temperature as a marketable health protection product for a contagious disease conscious society.

Scope for Setting Different Project Learning Scenarios

Science education was criticized as disappointing in U.K. based on the observation that despite undertaking 12 years of compulsory science education, the majority of students still appear to "lack any familiarity with the scientific ideas which they are likely to meet outside schools. ([Millar and Osborne, 1998: p.4](#)) The curiosity, awe and wonder that the natural world inspires in younger pupils are not sustained. ([Warwick and Stephenson, 2002: p.143](#)) Even where apparently 'interactive approaches' are applied, practical work is sometimes offered as a matter of routine rather than as a means of developing procedural understanding and critical reflection. ([Hodson, 1990](#)) Warwick and Stephenson (2002) added one more, the "Failure of current curricula to emphasize the importance of discussion or analysis". Hence, the problem lies in how science is taught. So far, there has been too much emphasis on content transfer instead of nurturing the thrill of the learning process.

In the school we serve, student hygiene prefects on duty present to teachers their empirical problems in using the IR thermometers. The school Principal and laboratory technicians formed a team to conduct this investigation step by step. We explored the terrain and utilized what we learned from our study to train a team of student hygiene prefects to serve the morning patrol. They were encouraged to repeat the experiment after our demonstrations. They learned to restrict a fixed distance of the client from the IR thermometer device. This repeated demands soon become spontaneous, willing and understood positioning step on the client side. The student hygiene prefects are

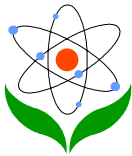

also very efficient to aim at the center above the nose and between the eyebrows once they understand the temperature distribution around the forehead. The rest would be routines. In other words, this opens up an opportunity for the learned student prefects to train juniors and hence another opportunity for leadership training. If we could start all over again, we believe we could include students in the investigation team.

As an independent project or as extra-curricular activity, without reminding students of the Inverse-square law, nor the distribution of temperature around the body, and definitely before showing one of the IR-thermographic images ([Fig. 11](#)), students could be encouraged to study the consistency of measuring with a single point targeting policy or a simplified multi-point circle targeting policy ([Fig. 10](#)). Experiments could then be explored as we did with exploring the Specification Requirements.

To go beyond the school setting, there can be scope for design of purpose built foolproof version of IR non-contact thermometer if students aim to advance in the technology field. Thorough understanding of the use and limitation of the IR thermometer device is definitely an advantage in the technical sales industry, in both marketing and technical training of clients.

Conclusion

"A key component of fostering learning is getting students to identify their ideas and then clarifying and challenging the validity of those ideas. This process enables students to redesign their thinking and create a stronger, more accurate structure of knowledge" ([Crockett, 2004](#)) We believe we have reclaimed a flexible learning space to link between science, technology and society for a diverse situations in schools.

Our exploration has opened up an opportunity to fulfill aims 1 through 5 of science education stipulated in the Curriculum Guide. Aim 6 and 7 would depend on the consistency and persistence in the operation plan of the teachers. Curiosity would be hindered if the opportunity to learn were organized in a random and chaotic manner. We definitely opened up opportunity for students to realize how they could equip themselves to be a successful technical salesperson or a designer in technology should they decide to pursue such a career.

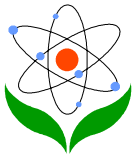

References

- Crockett, Cynthia. (2004) What Do Kids Know -- and Misunderstand -- About Science?. *Educational Leadership* 61(5): 24-27. February
- Curriculum Development Council. (2002). *Key Learning Area Curriculum Guide (Primary 1 to Secondary 3): Science Education*. Hong Kong.
- Hodson, D. (1990). A Critical Look at Practical Work in School Science. *School Science Review* 70 (256), 33-40.
- Millar, R. & Osborne, J. (1998). *Beyond 2000, Science Education for the Future*. London: Nuffield Foundation.
- Warwick, P. & Stephenson, P. (2002). Reconstructing Science in Education: Insights and Strategies for Making It More Meaningful. *Cambridge Journal of Education* 32 (2), 143-151. U.K.
- Wheatley, M. J. (1999). *Leadership and the New Science: Discovering Order in a Chaotic World*. 2nd Edition. San Francisco: Berrett-Koehler Publishers.

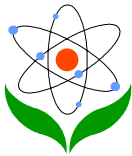

Report

Preamble

During the SARS crisis in 2003, we joined the onrushing crowd purchasing a few sets of infrared thermometer for measurement of students' body temperature before they enter the school. It was thought that such "hi-tech" device could provide us fast and convenient way of screening students from those having fever, a symptom of SARS. However, after a fairly long period of practice, it was found that readings on display of such devices varied in a range wide enough to make us unsure whether a student is having fever or not. Despite the calibration, the IR non-contact devices seemed not offering out consistent readings about a person's forehead temperature, sometimes ranging from 27°C to 33°C, which was so confusing. Therefore we decided to take a deep look into the matter to see what was happening. Below are our findings that we'd like to share with all those encountering similar situations.

Our Sequence of investigation

At first, we suspected that the device was not well calibrated or mal-functioning. Hence we shipped them back to the factory requesting a thorough check as well as certified calibrations. We were confirmed that the devices were functioning as designed and calibrated as specified. Mal-functioning is not a reason to the fluctuations of readings. We could reject malfunctioning as a reason if we could prove that temperature displayed on the IR thermometer followed a straight line with rise and fall in temperature range between 22 to 55 degree Celcius. The same applied to our Data-Logger. Then we could countercheck temperature readings reciprocally using both devices. Hence we started our explorations for the whys and wherefores.

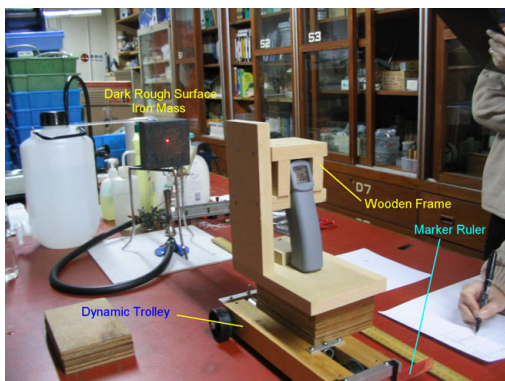

Pic. A

First of all, adopting the temperature sensors of the Data-Logger set, we decided to repeat the calibration on our own. The purpose of doing this is to make sure the device is accurate to an extent enough for our aim or, if not, how far it was from behaving as what was designed to feature. We used a Data-Logger temperature sensor to

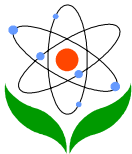

countercheck the linear response of the IR thermometer. To facilitate the calibration process, a wooden frame was constructed to hold the device under test firm in position and mounted on a dynamic trolley available in school Physics Laboratory as shown on the left. Markers were also adhered to the trolley as pointers indicating distances from the object being measured. The wooden frame was so mounted that the laser pointer from the device was pointing approximately the middle region of the object being measured. Since shiny surfaces exhibit low emissivity of infrared wave, an iron mass of about 3 Kg with dark and rough surface was used as the object to be measured. To avoid fast heat loss while taking readings, such a heavy object was believed to possess adequate heat capacity.

1. Calibration (Linearity Response Counterchecked with Data-Logger Sensor)

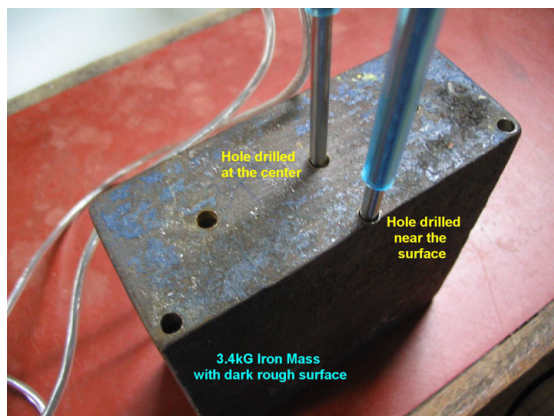

Pic. B

Holes were drilled on the 3 Kg iron mass. The first one was drilled in the middle of the top face deep enough to reach the center of the mass inside for the first sensor to measure the inner temperature of the object. The second one was drilled just beneath the front surface for the second sensor to monitor the surface temperature which should most possibly match with that on the infrared thermometer display as expected.

In the first part, the mass was then heated up with a Bunsen flame to approximately 90°C at the beginning. It was then allowed to cool down gradually to room temperature while taking readings both from data logger and infrared thermometer simultaneously. See Fig. 1 below.

In the second part, the mass was then placed inside the freezer of a fridge to cool down to about -15°C at the beginning. It was then allowed to warm up gradually to room temperature while taking readings both from Data-Logger and infrared thermometer simultaneously. See Fig. 2 below.

Then 2 curves of the infrared readings against the inner temperature readings and the surface temperature readings were plotted respectively as indicated below in Fig. 3. It can be seen that the 2 curves were very close to straight lines which implied linearity

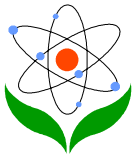

characteristic of the infrared thermometer. In both Fig. 1 and Fig. 2, the blue line stands for infrared thermometer reading. The red line stands for the surface temperature detected by Data Logger. The green line stands for the inner temperature detected by the second sensor of Data Logger. Judging from Fig. 1 and Fig. 2 the infrared detector exhibited a linear responding characteristic as that of the temperature sensor monitoring the surface of the iron mass except with a constant difference that seemed to be a calibration problem. Looking from the slopes of the curves in Fig. 3, we found that the Data-Logger sensor and IR thermometer were both acceptable for the purpose of our investigations despite exhibiting different linear thermal properties.

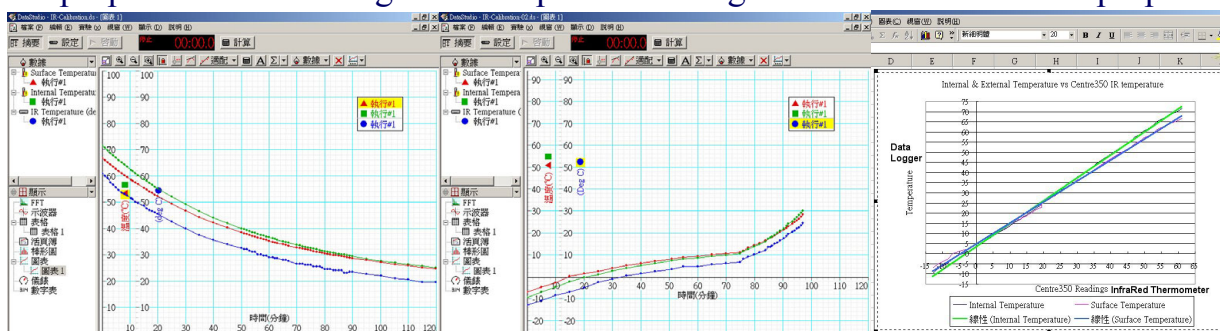

Fig. 1

Fig. 2

Fig. 3

After confirmation of the response characteristic of the infrared thermometer, we started exploring suspected possible causes of the fluctuations.

Suspected reasons of fluctuation include :

- Battery voltage drop after current consumption has reached a certain level
- Low quality and/or poor stability of the device
- Ambient temperature of the environment where the device is being used
- Skill of the operators holding the device
- Specifications requirement of the device not matched when being used

2. Battery Voltage Drop

Since the device is powered by 009P type 9V battery with a current capacity of about 400mAH only, the first and most suspicious reason was voltage drop due to long time usage. To begin with, we had prepared two pieces of 009P batteries beforehand, one discharged with a current of about 200mA by a light bulb for approximately one and a half hour to about 6V and the other one brand new. Then the infrared thermometer was first fitted with a brand new battery and mounted on the wooden frame. Pointing

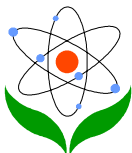

at a 3Kg iron mass with dark rough surface preheated to about 40°C at a distance of about 30cm, the temperature reading was recorded. Then we changed the new battery with the exhausted one. Temperature reading was taken again at the same distance. In order to be sure, the process was repeated 5 times with data recorded as below.

	Trial #1	Trial #2	Trial #3	Trial #4	Trial #5
New Battery	39.5°C	39.0°C	38.5°C	38.0°C	39.5°C
Exhausted Battery	39.5°C	40.0°C	39.5°C	39.5°C	39.0°C

From the table above, it was concluded that battery voltage had no significant influence on the readings of temperature detected. Therefore, battery voltage drop was NOT a cause of the fluctuation.

3. Low Quality and/or Poor Stability

Quality and/or stability of the device could affect the output result quite dramatically. However, it was not difficult to check this out. The 3Kg iron mass was preheated to about 40°C and allowed to cool gradually. The infrared thermometer was then pointed at the center of the iron mass at a distance of 30 cm and reading taken. The process was repeated 5 times at intervals of 15 seconds. Result was recorded as below.

	Trial #1	Trial #2	Trial #3	Trial #4	Trial #5
Time	0 second	15 seconds	30 seconds	45 seconds	60 seconds
Temp Reading	38.5°C	38.0°C	38.5°C	38.5°C	38.0°C

From the table above, it was clearly shown that readings were in consistency after 5 trials within a minute of time. Therefore, stability of the device was quite satisfactory.

4. Ambient Temperature Test

Another suspicious cause of inaccuracy or fluctuations was ambient temperature. Since the environment where we take body temperatures of students were at the main gate of the school and it was occasionally windy. Thus, some of our staff suspected that cold air blowing over the forehead could possibly affect very much the temperature detected. Hence we set up the experiment below to take a closer look into this.

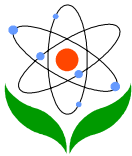

Fig. 4

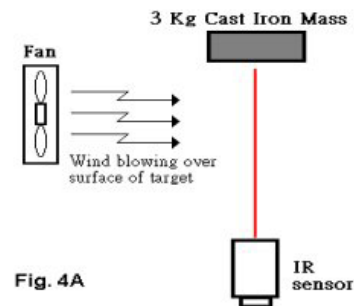

Fig. 4A

As consistent standard, the 3 Kg mass was preheated to about 40°C and allowed to cool gradually. But this time, we mounted a computer type mini cooling fan in front of the heated mass as shown such that cool air could be blown over the surface of the heated mass when necessary. Then readings were taken under 4 conditions as follows :

	Situations		Temp
(1)	The infrared thermometer was pointed at the pre-heated mass with the fan turned OFF	T1	37.5°C
(2)	The infrared thermometer was pointed at the pre-heated mass with fan turned ON and cool air blown from left to right over the surface	T2	37.5°C
(3)	The infrared thermometer was pointed at the pre-heated mass with fan turned OFF again	T3	37.0°C
(4)	The infrared thermometer was pointed at the pre-heated mass with fan turned ON and cool air blown from right to left over the surface	T4	36.5°C

The time intervals between each successive reading taken were 30 seconds approximately. It was noticed that cool air either blowing from left to right or right to left over the heated surface of the iron mass did not bring much difference to the infra-red detection reading. The temperature drop of about 1 degree after 2 minutes is more likely being caused by natural cooling of the mass itself.

It became obvious that cool air blowing over the surface of the object being detected did not cause significant effect in its emission of infrared energy. Therefore, ambient temperature variation was NOT a cause of the fluctuation either.

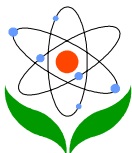

For further confirmation that ambient temperature was not a factor to cause inaccuracy, a Bunsen flame instead of the computer cooling fan was placed in three different positions nearby the 3 Kg mass as that indicated below. As expected, the Bunsen flame did not cause any significant fluctuations in the IR readings. Temperatures recorded in these 3 cases were approximately 36°C only.

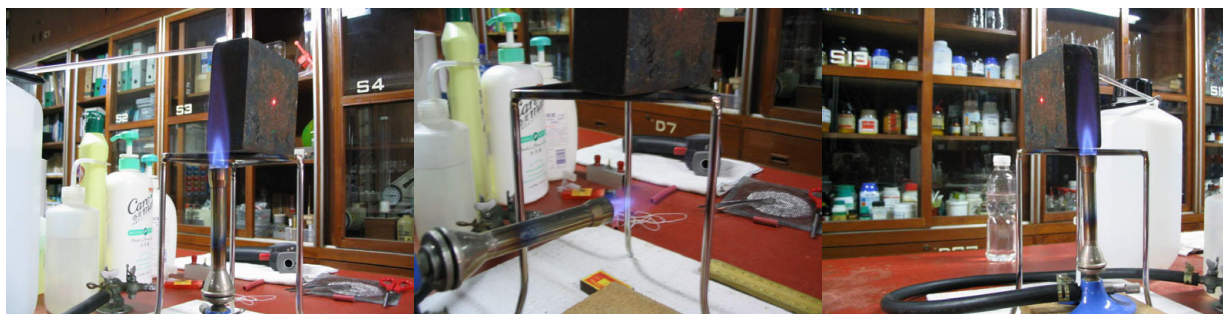

Fig. 5

Fig. 6

Fig. 7

5. Handgrip and Attitudinal Test

A series of tests had been used to investigate the fluctuation of the device, but still could not find out what the main reason was. It was quite disturbing to us. We began to investigate human factors, to simulate how users may use the device to measure the body temperatures of students by considering their attitude (focused vs. casual) in gripping the device. Since there was a built-in laser pointer on the device, three kinds of aiming method were tried to see whether there were any new findings or not.

- (1) Measurement with assistance of Laser Beam Aiming
- (2) Measurement with assistance of Naked Eye Aiming in concentrated way
- (3) Measurement WITHOUT any aiming assistance in approximate way

This time, the IR thermometer was held in hand as usual and measurements were taken from 5 different directions.

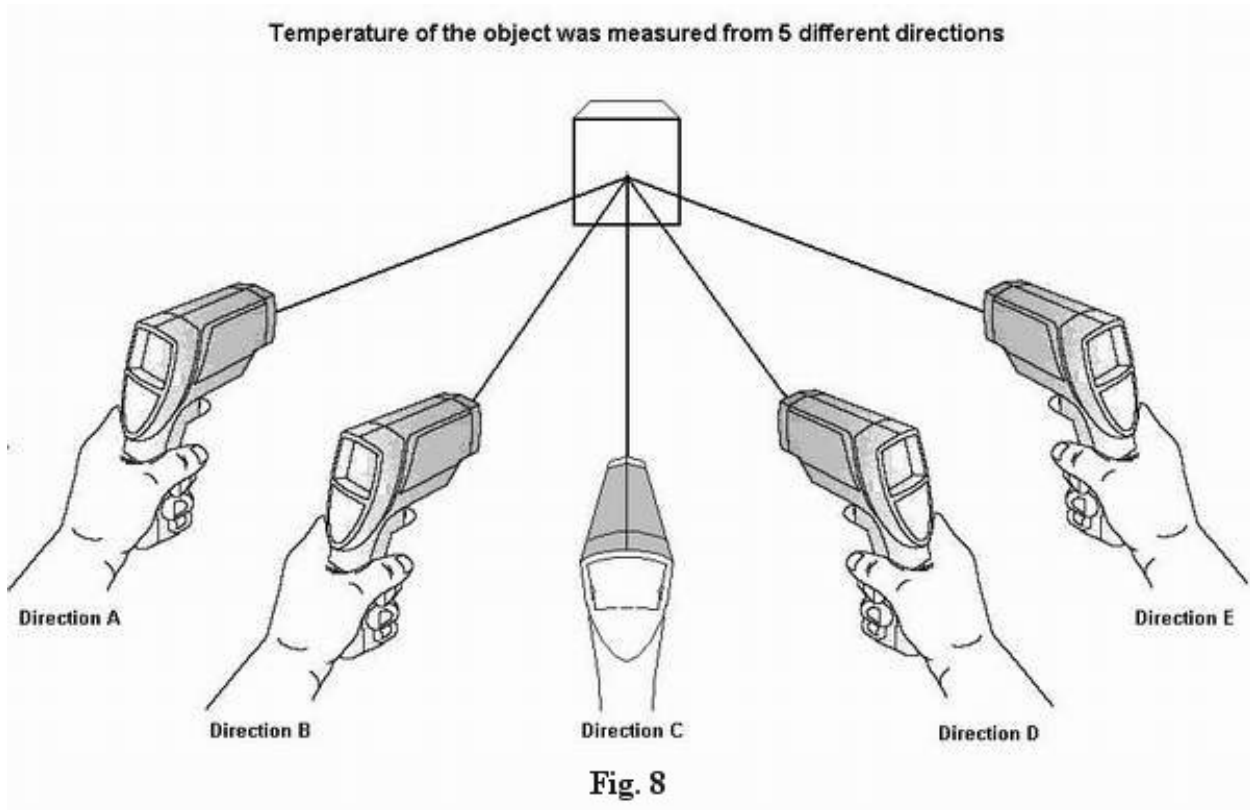
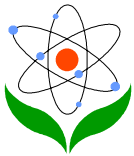

Distance from the mass to the device was not fixed during measurements so as to simulate the actual situations. Results were recorded as below.

Aiming Assist	A	B	C	D	E
Laser Beam	35.5°C	34.5°C	34.0°C	34.5°C	34.0°C
Naked Eye Aim	35.0°C	31.0°C	33.5°C	32.0°C	28.5°C
Approx. Aim	34.5°C	24.0°C	33.0°C	33.0°C	19.0°C

From the table above, variations of readings were found in the test. It seemed that we're on the track of discovering something related. Hence, we carried on to the ***up-tilt/down-tilt test*** to see what else further could be found. In this session, the aiming laser beam was directed from the same origin to 5 different spots (Center, Upper edge, Lower edge, Left edge and Right edge) as indicated below.

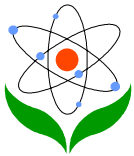

Temperature measured by pointing the laser beam at 5 different spots as indicated S1 S2 S3 S4 S5

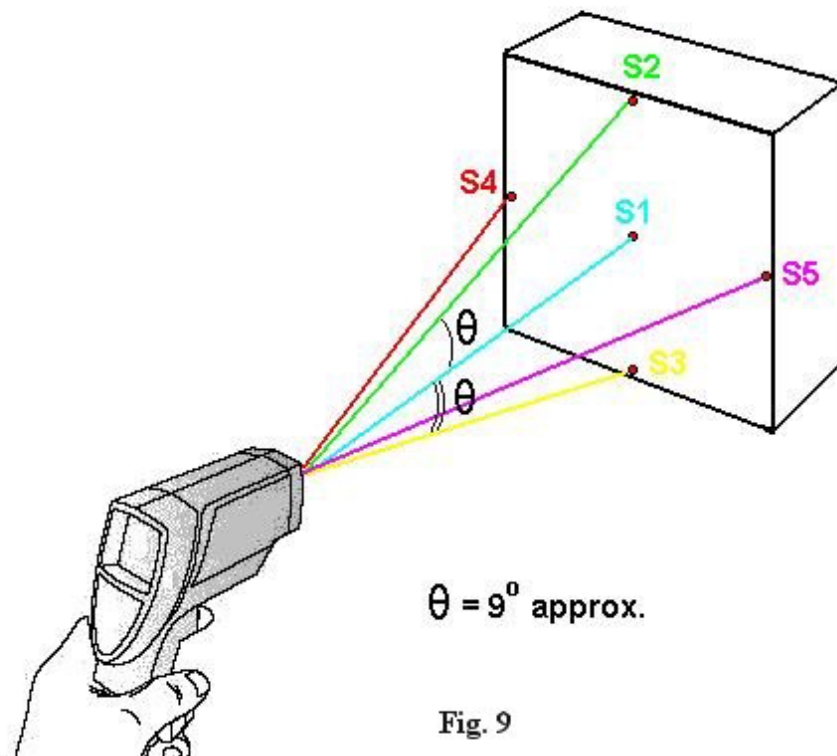

Then readings taken under 5 conditions were as follows :

	Situations		Temp
(1)	The infrared thermometer was pointed at the Centre of the pre-heated mass with laser beam	T1	32.0°C
(2)	The infrared thermometer was Up Tilt with the laser beam located just at the upper edge of the pre-heated mass	T2	34.5°C
(3)	The infrared thermometer was Down Tilt with the laser beam located just at the lower edge of the pre-heated mass	T3	16.5°C
(4)	The infrared thermometer was pointed at the Left hand side of the pre-heated mass with the laser beam just falling outside the mass	T4	30.0°C
(5)	The infrared thermometer was pointed at the Right hand side of the pre-heated mass with the laser beam just falling outside the mass	T5	20.5°C

The angle up- or down-tilt measured was as small as 9° only. Such a small deviation of angle in holding gesture did really cause a significant variation in the readout of the

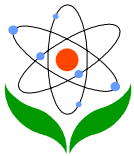

device.

From the table above, it was found that holding gestures of the users was the main reason in causing erratic fluctuations of readings to the device. We therefore considered that maybe it was the specification requirements of the device were not matched when being used. After perusal of the operation manual of the IR thermometer, several points were noted.

6. Specification Requirement

According to the operation manual, the device being used should follow the “Distance to Spot Ratio” requirement. The detection area must be larger than the required spot size to get correct readings. See ”Field of View” below.

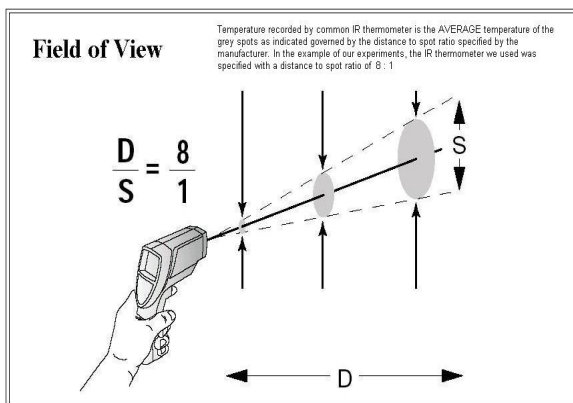

Pic. C

As the reading shown on display was the AVERAGE temperature of the detected region, errors can easily occur if the object to be measured cannot fill up the Field of View of the detection spot. For example, if the diameter of the spot with consistent body temperature on human forehead was only about 40mm, the device should thus be placed at about 320mm away from the detected region all the time.

The device displaying higher values of readings means the more capability of radiation emittance the materials have. Emissivity means the energy-emitting characteristics of materials. This was also a factor of causing inaccuracy.

The information below shows different devices with different characteristics. Fig. 10 shows the specification of other brand's infra red thermometer. Laser sighting e.g. single spot, 8-point circle, 17-point circle with or without focus. Distance to Spot Ratio e.g. 6:1, 8:1, 12:1, 50:1 etc. Emissivity can be adjustable or fixed. Maximum temperature they can reach are different. All these criteria influence the accuracy of the readings we take. Fig. 11 shows the distribution of emissivity of a human body. The white lines on the human forehead clearly separate the temperatures into regions. The regions change from time to time according to the blood flow through the human

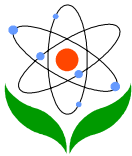

instrument simply by quoting that the readings are near to normal body temperature of human beings is not scientific at all. Judging the accuracy of the instrument could be counter-intuitive.

The next step was to conduct some more tests to see which one will be more accurate. Here are our results below.

Two different brands of devices were used to detect a high temperature (the 3 Kg iron mass heated to about 40-50°C) and a low temperature (a black painted beaker of melting ice) for comparison. In both cases, a common laboratory type of alcohol thermometer was used as reference. Fig.13 and 14 represents the device said to be inaccurate while Fig.15 and 16 represents the device claimed to be more accurate when measuring the body temperature of human forehead.



Fig. 13

Fig. 14

Fig. 15

Fig. 16

Strange !! Taking a closer look into the photos, device in Fig.13 and 14 was found more accurate than that of Fig.15 and 16.

It was really an interesting finding. Here, we may say that simple conclusions originated from erratic data could possibly lead to quite an opposite finding about a phenomenon of science. Our minds were bogged with established norm values. Many "concepts" have been planted inside our brain so firmly since we were born and brought up. These "concepts" sometimes reduce our curiosity in many aspects, mitigate our sensitivity of nuances, and make us neglect search for solid evidence. We knew from the [calibration curve](#) we presented earlier that the IR non-contact thermometer in our tests carried a calibration problem. However, it is still an accurate device on condition that we follow its requirement of distance to spot ratio as well as confirm the spot covers the region to be measured.

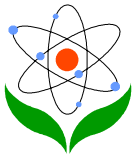

	Brand A	Brand B
Field of View (Distance to Spot ratio)	8:1	12:1
Emissivity	0.98	0.95
Temperature Range	-20 ~ 500°C	-32 ~ 400°C
Accuracy	±2°C	±1°C (Above 23°C) ±2°C (-18 ~ -23°C) ±2.5°C (-26 ~ -18°C) ±3°C (-32 ~ -26°C)
Type of Sighting	Single spot	
Operation condition	<p style="text-align: center;">Pic. D</p>	

However, for measurement of human body temperatures, it seems not an appropriate one. Even with one offering a closer range of reading at the desired zone, the advertisement of local dealers could be very different from the opinion of the technical experts from the manufacturer.

Let us share the official reply from one of the infrared thermometer manufacturer.

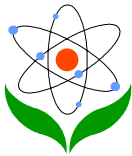

Ask ourselves the following question :-

(1) Was the IR thermometer designed for our purpose of measuring human body temperature? The clue may be in the range of reading that the device serves. If it is from -20°C through 400°C or higher, it probably serves to measure the temperature of a stove, a larger heat source with poisonous reaction mixture in an industrial process, etc.

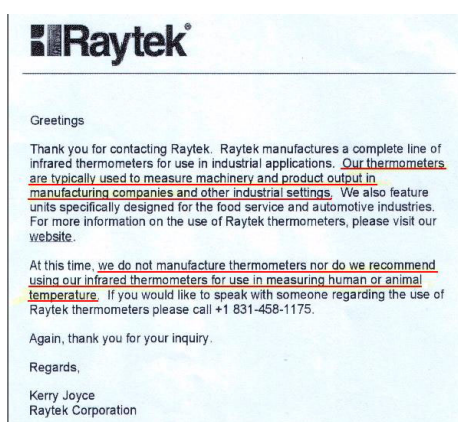

(2) What happens if nobody queried? We may never have the desired foolproof purpose-built device. A handy handheld product is still needed in the combat against fatal diseases that bear early fever symptom. That is another marketable demand in the future health protection industry.

TO CONCLUDE

USE THE RIGHT DEVICE TO DO THE RIGHT THING !!

Acknowledgement

Special thanks to *Mr. KW Yu* of PLK Yao Ling Sun College for technical assistance in animation effects. We appreciate the rich information supplied in the catalogue of IR thermometers provided by Raytek (www.raytek.com). Again, we express our deepest thankfulness to Raytek for the prompt official reply in response to our inquiry.