

An analysis of prospective chemistry teachers' cognitive structures through flow map method: The subject of oxidation and reduction

Senar TEMEL

**Hacettepe University, Faculty of Education, Department of Chemistry
Education, TURKEY**

E-mail: senar@hacettepe.edu.tr

Received 11 Apr., 2016

Revised 26 Dec., 2016

Contents

- [Abstract](#)
 - [Introduction](#)
 - [Significance of the Study](#)
 - [Purpose](#)
 - [Method](#)
 - [Research Design](#)
 - [Study Groups](#)
 - [Data Collection Tool](#)
 - [Data Analysis](#)
 - [Findings](#)
 - [Discussion and Conclusion](#)
 - [Recommendations](#)
 - [References](#)
-

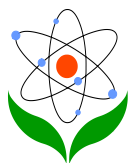

Abstract

This study aims to analyse prospective chemistry teachers' cognitive structures related to the subject of oxidation and reduction through a flow map method. Purposeful sampling method was employed in this study, and 8 prospective chemistry teachers from a group of students who had taken general chemistry and analytical chemistry courses were included in the study. To determine participants' cognitive structures related to the subject of oxidation and reduction, participants were asked two questions which did not guide them. Then the answers they gave to the questions were collected, and a flow map for each participant was prepared. The flow maps obtained through participants' written narratives were analysed in terms of quantitative variables used in presenting cognitive structures in quantitative statements. On examining participants' flow maps in accordance with all the quantitative variables used in presenting cognitive structures, it was found that prospective chemistry teacher 8 had the largest comprehensive cognitive structure, prospective chemistry teacher 4 had the medium comprehensive cognitive structure whereas prospective chemistry teacher 1 had the narrowest comprehensive cognitive structure. Participants' misconceptions were also determined through flow maps.

Keywords: Cognitive structure, constructivist theory, flow map method, oxidation and reduction, misconception

Introduction

It has been exhibited in many studies that students have inadequacies in conceptually understanding the basic subjects of chemistry (Cracolice, Deming, & Ehlert, 2008; Mason, Shell, & Crawley, 1997; Nakhleh, 1993; Nakhleh & Mitchell, 1993; Pickering, 1990; Sawrey, 1990). Pendley, Bretz, and Novak (1994) list the factors underlying the problems that students encounter in understanding the concepts and principles of chemistry as follows: 1) students' prefer to memorise rather than learn meaningfully, 2) because the subjects of chemistry mostly seem conceptually incomprehensible to students, students fail to notice the key concepts and the relations between concepts necessary for understanding the subjects of chemistry, and 3) as a result of failure of instruction to present the key concepts and the relations between those concepts, there is an apparent incomprehensibility surrounding those concepts and principles conceptually for students.

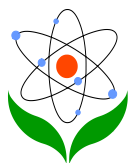

Conceptual understanding plays a significant role in acquiring new knowledge in a field and in applying the knowledge to problem-solving cases (Bascones & Novak, 1985; Lavendowski, 1981; Novak, 1977; Novak, Gowin, & Johansen, 1983). Constructing a very well organised conceptual framework, which is a requirement for conceptual understanding, requires that students prefer meaningful learning instead of rote learning. Meaningful learning occurs through students' establishing conceptual associations between their relevant knowledge and the new knowledge presented to them (Ausubel, 1968). When meaningful learning does not occur, rote learning comes into prominence. In consequence of rote learning, students cannot associate new knowledge with prior knowledge effectively, instead they just memorise the new material, and therefore they can forget it soon and cannot transfer it (Bretz 2001; Novak & Gowin, 1984). Besides, meaningful learning is an active process, and it requires that students activate the cognitive framework so that they can combine the new knowledge effectively (Bischoff & Anderson, 2001). Thus, it is important for students to grasp the basic concepts, and the way they associate those concepts is important. Since chemistry is a complex science studying many abstract issues and concepts, it requires students to understand the subjects of chemistry, and the related concepts and ideas, i.e. to develop coherent and consistent structures (Burrows & Mooring, 2015).

Cognitive structure is a structure showing the interconceptual relations in students' long-term memory (Shavelson, 1974). Studies conducted in relation to cognitive structure are harmonious with constructivist theory (Anderson, 1992; Bodner, 1986). Constructivist theory contends that knowledge is actively constructed by students and not simply stored in memory (Howard, 1988). Knowledge is not directly communicated, but it is actively constructed by learners (Bodner, 1986; Fosnot, 1996). Therefore, even if learners in the same learning environment are presented the same knowledge and the same learning conditions, they develop different cognitive structures and different ways of organising the knowledge (Howard, 1988). Assessing learners' cognitive structures is an important indicator in evaluating what they know. Traditional pen-and-paper tests are usually used in assessing students' knowledge in chemistry education. This does not inform us much about interconceptual relations in students' mind, how they form relations, and how they organise knowledge in this way (Tsai, 2001). Evaluating the cognitive structure:

- helps educators to organise materials,
- enables educators to notice knowledge gaps in students' cognitive structures,
- enables educators to relate new materials to existing slots in students' cognitive structures (Jonassen, 1987),
- enables educators to notice the learning difficulties students have,

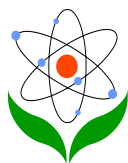

- enables educators to facilitate teaching (Snow, 1989).

Educators and constructivist scientists have made efforts to present students' cognitive structures in differing ways (Chin-Chung & Chao-Ming, 2001), and they have employed various methods, such as word associations (Gunstone, 1980; Shavelson, 1972), concept maps (Novak & Gowin, 1984), and flow maps (Anderson & Demetrius, 1993) for this.

A flow map is a method used in presenting students' cognitive structures (Anderson & Demetrius, 1993; Tsai & Huang, 2002), and was first developed by Anderson and Demetrius, (1993). The method of a flow map has been used by different researchers to analyse individuals' cognitive structures in diverse learning environments (Anderson, Randle, & Covotsos, 2001; Bischoff, 1999; Bischoff & Anderson, 1998; Dhindsa & Anderson, 2004; Tsai, 1998; 2000; 2001; Tsai & Huang, 2001; Oskay & Dinçol, 2001; Oskay, Temel, Özgür, & Erdem, 2012). Flow maps are formed by schematising the oral statements of students' thoughts (Tsai, 2001). While students' narratives obtained from interviews are mostly used in preparing flow maps, students' written narratives may also be used (Anderson, Randle, & Covotsos, 2001). They are used to show the sequential and multiple relational frameworks of ideas expressed by students because flow maps display both the sequential organisation and cross linkages between ideas available in students' narratives. In forming a flow map, firstly students' ideas are listed. Then links are set up between ideas by using sequential and diagonal relational arrows. Linear arrows showing the sequential flow of students' ideas, and recurrent arrows showing the linkages between relational statements are used in flow maps. The recurrent arrows are formed facing towards previously mentioned statements. Students' misconceptions are also listed and noted in flow maps because misconceptions present a part of cognitive structure, and the number of those misconceptions can be regarded as an indicator of the accuracy of students' conceptual frameworks (Tsai, 2001). Distinguishing misconceptions through flow maps and presenting them visually can be a useful tool for teachers and students of science to distinguish the fields which need improvement at the beginning of learning (Bischoff & Anderson, 1998).

When studied downward, flow maps offer information on the sequential development of ideas and on their linear connections, and when studied diagonally, they provide information on diagonal relational ideas (Anderson & Demetrius, 1993). Flow maps are used to:

- provide a descriptive and quantitative presentation of students' narratives,
- analyse cognitive structure when the sequential and multiple relational aspects of students' narratives are important,

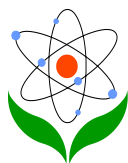

- demonstrate changes in the cognitive presentation of knowledge before and after learning,
- determine the current prior knowledge before teaching as a way of explaining the interaction between current knowledge and the acquisition of new knowledge,
- discuss with students what they think,
- help to correct the wrong interactions between events, if there are any (Anderson & Demetrius, 1993),
- enable teachers and educators to evaluate students' cognitive structures related to different aspects through quantitative analysis,
- perform content analysis of the basic scientific concepts that students remember,
- perform content analysis for students' information processing strategies,
- quantitative analyses of flow maps enable teachers to evaluate the structure, extent, richness, connections and accuracy of students' knowledge structure (Tsai, 2001).

Significance of the Study

In order for meaningful learning to occur, it is especially important for students to understand the basic concepts of a subject domain and the relations between those concepts, and thus to develop meaningful conceptual frameworks—that is to say, to develop cognitive structures. Based on this fact, this study aims to determine the cognitive structures of prospective chemistry teachers through a flow map method. A review of relevant literature shows that there are general studies related to high school students' cognitive structures (Anderson & Demetrius, 1993; Bischoff & Anderson, 1998; 2001; Chang, Yeh, & Barufaldi, 2010; Tsai, 2001), and studies related to various subjects (human digestive system—Anderson & Demetrius, 1993; the greenhouse effect and global warming—Chang et al., 2010; Oskay et al., 2012; the carbon cycle—Selvi & Yakışan, 2005; biological reproduction—Chin-Chung & Chao-Ming, 2001; the molecular kinetic properties of air—Bischoff, 2006). Moreover, the fact that the number of studies concerning the subjects of chemistry is limited (atom model—Tsai, 2001; ethanoic acid—Zhou, Wang, & Zheng, 2015; oxidation and reduction—Bischoff, Avery, Golden, & French, 2010; hybridisation and bonds—Oskay & Dinçol, 2011; chemical bonds and the structure of the atom—Dhindsa & Anderson, 2004; covalent and ionic bonding—Temel & Özcan, 2016), and particularly that the number of studies performed in Turkey is limited (Karagöz Şahin, 2004; Oskay & Dinçol, 2011; Oskay, et al., 2012; Selvi & Yakışan, 2005; Temel & Özcan, 2016) contribute to the importance of this study.

Purpose

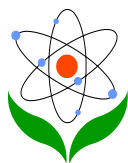

This study aims to analyse prospective chemistry teachers' cognitive structures related to oxidation and reduction subject to a flow map method.

Method

Research Design

Case study—one of the qualitative research methods—was used in this study. Case study is an approach used in searching for answers to scientific questions (Büyüköztürk, Kılıç Çakmak, Akgün, Karadeniz, & Demirel, 2013).

Study Group

Purposeful sampling method was employed in this study, and 8 prospective chemistry teachers from a group of students who had taken general chemistry and analytical chemistry courses were included in the study. Through purposeful sampling method, key people can be chosen to collect more extensive and in-depth data in a group instead of focusing on all participants in the group (Büyüköztürk et al., 2013).

Data Collection Tool

Flow map method

The subject of oxidation and reduction that is a complex topic in which students have difficulty, was chosen in the study (Valanides, Nicolaidou, & Eilks, 2003). Firstly, participants were asked to write what they knew about the subject of oxidation and reduction. For this aim, they were asked two questions which did not guide them. They are as follows:

- What are the main concepts of the subject of oxidation and reduction?
- What is your opinion of the actions based on oxidation and reduction reactions?

The participants answered the questions individually and they were given approximately 30 minutes to answer. Then the answers they gave to the questions were collected, and a flow map for each participant was prepared by the researcher. The sequential flow of participants' ideas about the subject was represented with linear arrows while the linkages between related ideas were demonstrated with recurrent arrows in the flow map. The recurrent arrows were used in the direction of the ideas that the participants had previously stated. Misconceptions providing information on the accuracy of their cognitive structures were also represented in the flow map.

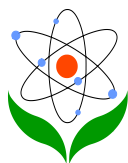

The reliability of the flow map method.

The reliability of the flow map method was secured by consulting a second independent researcher who is an expert in chemistry education and has undertaken studies related to the use of a flow map method to diagram participants' narratives. Inter-coder agreement for sequential statements was around 0.92, and for recurrent linkages was around 0.88. Since it is considered sufficient for narrative analysis if the reliability is greater than 0.80 (Tsai & Huang, 2001), it can be said that this flow map method was sufficiently reliable for the purpose of this study.

Data Analysis

The flow maps obtained through prospective chemistry teachers' written narratives were analysed in terms of quantitative variables used in presenting cognitive structures in quantitative statements. The quantitative variables included in the analysis were as follows:

- Extent: The total number of ideas in the flow map (the number of linear linkages),
- Richness (recurrent linkages): The number of recurrent linkages in the flow map,
- Integratedness: $\text{Richness} / (\text{Extent} + \text{Richness})$,
- Accuracy: The number of misconceptions in the flow map (Tsai, 2001).

Findings

The flow maps derived for each prospective chemistry teacher (P) were analysed according to the mentioned quantitative variables in this study. The results obtained are shown in Table 1.

Table 1: The cognitive structure outcomes of prospective chemistry teachers

Variables	P1	P2	P3	P4	P5	P6	P7	P8
Extent	11	10	9	13	12	12	12	15
Richness	5	5	5	8	8	8	8	10
Integratedness	0.31	0.33	0.35	0.38	0.4	0.4	0.4	0.4
Accuracy	1	1	0	0	0	0	0	0

A close examination of Table 1 makes it clear that the number of linear linkages providing information concerning the extent of knowledge that prospective chemistry teachers remembered ranges between 9 and 15, whereas the number of linkages providing information on the richness of knowledge linkages ranges between 5 and 10. Accordingly, we see that the

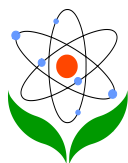

variable of integratedness receives values between 0.31 and 0.4, and that the number of misconceptions (accuracy) is 1 at most. The misconceptions determined are shown in Table 2.

Table 2: Misconceptions determined

Misconceptions
1. Oxidation state is the number of electrons an ion has.
2. Oxidation state is the stage at which an element gains electrons.

Also, the flow maps of P8, P4 and P1 are examined in detail. The flow map formed from the written narrative of P8 is shown in Figure 1.

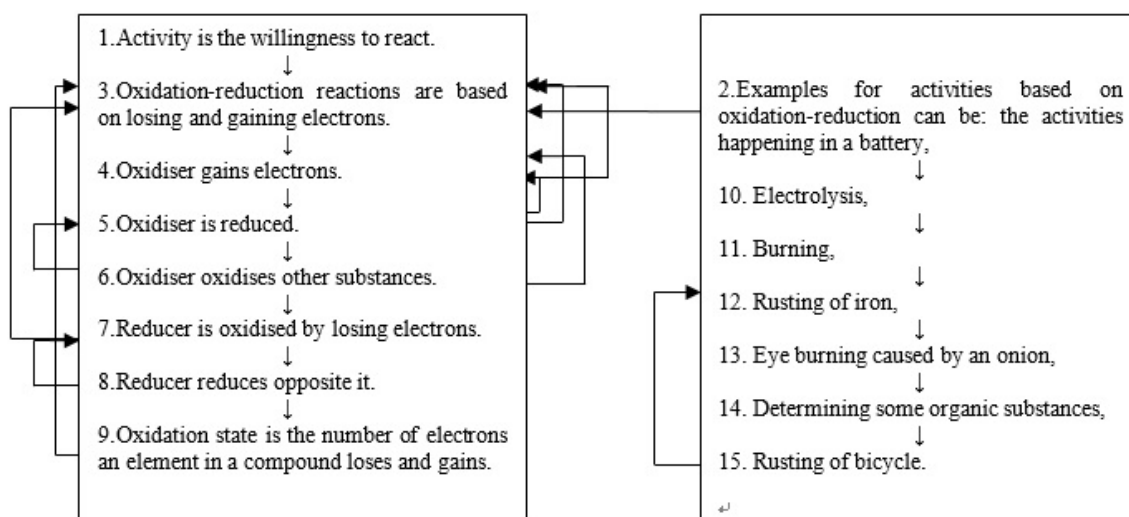

Figure 1

According to Figure 1, the number of total ideas (the number of linear linkages) in the flow map for P8 is 15, and the number of recurrent linkages is 10. On examining the recurrent linkages, it is found that item 5, for instance, “oxidiser is reduced”, is linked to item 3, “oxidation-reduction reactions are based on losing and gaining electrons”, with a recurrent arrow because it contains reduction which was mentioned before. In the same way, item 6, “oxidiser oxidises other substances”, is linked to item 4, “oxidiser gains electrons”, with a recurrent arrow since it contains the previously mentioned expression oxidiser. Item 4, “oxidiser gains electrons”, is linked to item 3, “oxidation-reduction reactions are based on losing and gaining electrons”, with a recurrent arrow since it contains the previously mentioned expression, gaining electrons. Figure 2 shows the flow map formed from the written narrative of P4.

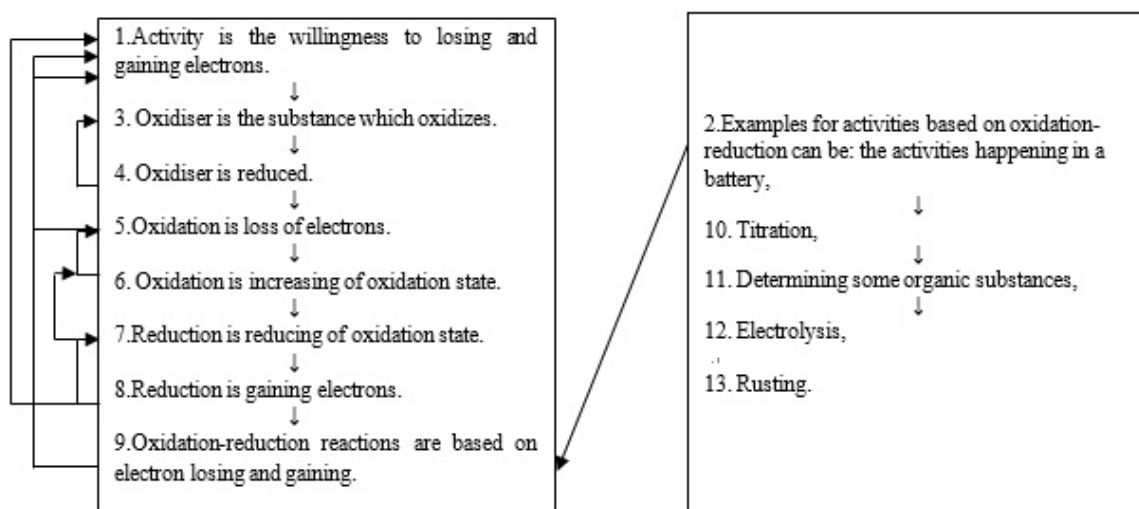
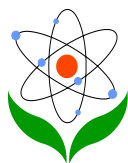
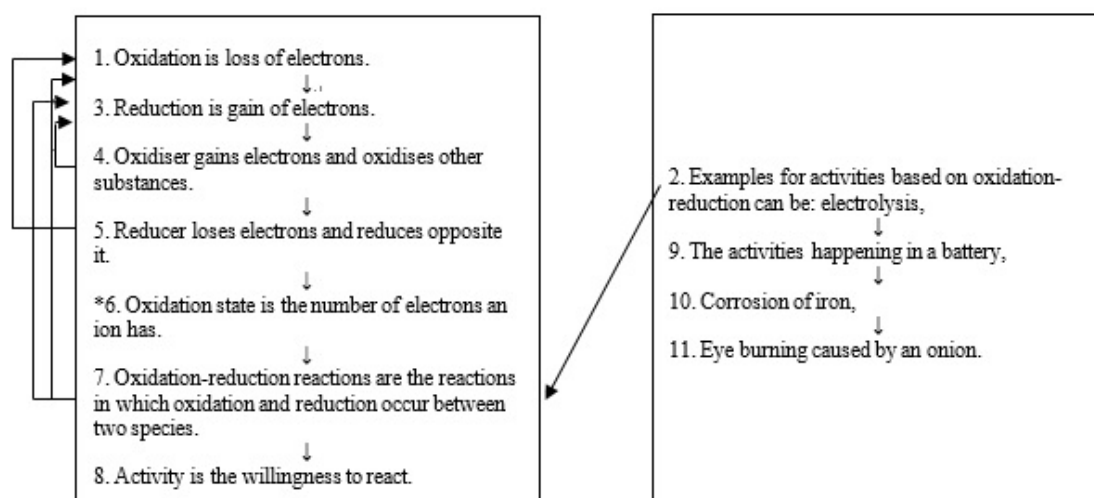

Figure 2: The flow map formed from the written narrative of P4.

According to Figure 2, the number of total ideas (the number of linear linkages) in the flow map for P4 is 13, and the number of recurrent linkages is 8. On examining the recurrent linkages, it is found that item 8, for instance, “Reduction is gaining electrons” is linked to item 1, “Activity is the willingness to losing and gaining electrons” with a recurrent arrow because it contains gaining electrons which was mentioned before. In the same way, item 9 “Oxidation-reduction reactions are based on electron losing and gaining” is linked to item 1 “Activity is the willingness to losing and gaining electrons” with a recurrent arrow since it contains the previously mentioned expression losing and gaining electrons. Figure 3 shows the flow map formed from the written narrative of P1.



* Misconception

Figure 3: The flow map formed from the written narrative of P1.

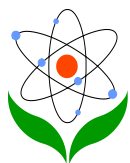

As is clear from Figure 3, the number of total ideas (the number of linear linkages) in the flow map for P1 is 11, while the number of recurrent linkages is 5, and the number of misconceptions is 1. On examining the recurrent linkages, it is found that item 4, for instance, “oxidiser gains electrons and oxidises other substances”, is linked to item 3, “reduction is gain of electrons”, with a repeated arrow because it contains the previously mentioned expression electron gaining. Similarly, item 7 “oxidation-reduction reactions are the reactions in which oxidation and reduction occur between two species”, is linked to item 1, “oxidation is loss of electrons”, because it contains the word oxidation, and to item 3, “reduction is gain of electrons”, with a recurrent arrow because they contain the statement, reduction. Also, item 6 in the flow map, “oxidation state is the number of electrons an ion has”, is a misconception.

Discussion and Conclusion

Flow maps were prepared in this study in order to analyse prospective chemistry teachers' cognitive structures in relation to the subject of oxidation and reduction. An examination of the flow maps showed that participants were able to define the concepts of “activity, oxidation, reduction, oxidiser, reducer, and oxidation state” in general. It was also found that prospective chemistry teachers often gave such examples as the activities happening in a battery, electrolysis, rusting of iron, and instances of burning, for the activities based on oxidation and reduction reactions. Therefore, it was clear that the prospective chemistry teachers had an accumulation of current knowledge on the subject. The flow maps prepared in order to determine the status of this accumulation of their current knowledge—this cognitive structure—from the perspective of extent, richness, integratedness and accuracy were analysed according to the quantitative variables suggested by Tsai (2001). According to Tsai and Huang (2002), flow maps offer more information for analysing the variables related to cognitive structure (extent, correctness, integration, availability, analyses of information-processing strategies) than other methods. In a similar way, Anderson and Demetrius (1993), Bischoff (2006), Chang, Yeh, and Barufaldi (2010), Dhindsa and Anderson (2004), and Tsai (2001) also used flow maps in their studies to analyse students' cognitive structures. Karagöz Şahin (2004) also analysed the conceptual dimension and dynamics of students' cognitive structures and information-processing strategies, as well as their misconceptions, by using flow maps.

On examining prospective chemistry teachers' flow maps in accordance with all the quantitative variables used in presenting cognitive structures, it is found that P8 had the largest comprehensive cognitive structure, P4 had the medium comprehensive cognitive structure whereas P1 had the narrowest comprehensive cognitive structure. The small number

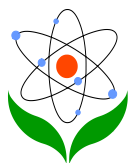

of recurrent linkages, in particular, displays quite limited opinion connections and a weak development of content schema (Bischoff & Anderson, 2001). Moreover, through the flow maps examined, it was found that prospective chemistry teachers had knowledge insufficiencies in their cognitive structures. For instance, not all of the participants mentioned the concept of “activity”, and those who mentioned it defined it as “willingness to react”. Only P4 mentioned the relations between willingness to react and elements’ bias to gain or lose electrons, but none of them mentioned the relations between willingness to react and whether or not reactions can occur spontaneously. Nor did they mention the relation between “activity” and “the order of activity”. They did not mention the relations between the oxidising and reducing tendency of a substance, either. They defined the concepts of “oxidiser” and “reducer”, but they could not set up relations, such as an oxidising substance was a reduced substance and a reducing substance was an oxidised substance simultaneously. The prospective chemistry teachers listed examples of actions based on oxidation and reduction reactions, yet none of them mentioned “termites”. Selvi and Yakışan (2005) in their research aiming to exhibit prospective biology teachers’ cognitive structures related to the carbon cycle through flow maps, found that there were insufficiencies in the extent of knowledge related to the carbon cycle during recall and in the relations between pieces of knowledge. The researchers also found that students could not fully describe in writing the basic stages of the cycle, and that they ordered their statements in a way so as to set up linear relations rather than to describe the cycle. Bischoff et al. (2010) aimed to analyse the development of prospective science teachers’ knowledge structures related to oxidation and reduction. Having analysed the prospective teachers’ knowledge structures through flow maps, the researchers found that the prospective teachers’ knowledge structures were not combined consistently around correct statements.

Prospective chemistry teachers’ misconceptions were also determined through flow maps. Those misconceptions are important in that they provide information especially concerning the accuracy of cognitive structures because the smaller the number of misconceptions, the more accurate the cognitive structure (Tsai, 2001). On examining participants’ misconceptions, it was found that they had misconceptions related to the concept of “oxidation state”. In their research Zhou, Wang, and Zheng (2015) attempted to discover high school students’ cognitive structures through flow maps, and to exhibit the learning difficulties they had in relation to ethanoic acid. As a result of the content analysis of flow maps, it was concluded that most of the students knew the main ideas about ethanoic acid, but that they were lacking details in parts and that their misconceptions were mostly related to molecular structure and with the esterification reaction. Chin-Chung and Chao-Ming (2001)

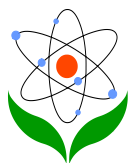

also used flow maps to assess students' cognitive structures related to biological reproduction and their information processing tendencies, and they also distinguished misconceptions.

Recommendations

In order for meaningful learning to occur, it is important that students understand the basic concepts of a subject, set up the right associations between concepts, and develop cognitive structures coherent with one another. Because a student's current cognitive structure is important in forming new learning, especially in the process of meaningful learning, it is necessary to check whether or not the current cognitive structure is meaningful and consistent, and to determine misconceptions, if there are any. Here, chemistry educators and teachers need to place emphasis on the main points of a subject while teaching it and to help students to establish associations between concepts, and organise the teaching in this way. Besides, it is important for chemistry educators and teachers to know that traditional pen-and-paper tests are insufficient for evaluating cognitive structures related to a given topic, and that diverse methods and techniques of evaluation need to be employed. Other measurement methods and techniques, along with flow maps—the best way to reveal cognitive structures and to determine partial understanding and knowledge insufficiencies—may be included in later research studies. Also interviews should be conducted with students to examine their cognitive structures in detail.

References

- Anderson, O. R. (1992). Some interrelationships between constructivist models of learning and current neurobiological theory, with implications for science education. *Journal of Research in Science Teaching*, 29(10), 1037–1058.
- Anderson, O. R., & Demetrius, O. J. (1993). A flow-map method of representing cognitive structure based on respondents' narrative using science content. *Journal of Research in Science Teaching*, 30(8), 953–969.
- Anderson, O. R., Randle, D., & Covotsos, T. (2001). The role of ideational networks in laboratory inquiry learning and knowledge of evolution among seventh grade students. *Science Education*, 85(4), 410–425.
- Ausubel, D. P. (1968). *Educational Psychology: A Cognitive View*. New York: Holt, Rinehart, and Winston.
- Bascones, J., & Novak, J. D. (1985). Alternative instructional systems and the development of problem-solving skills. *European Journal of Science Education*, 7(3), 253–261.
- Bischoff, P. J. (1999). The development of ideational networks, systemic knowledge, and application abilities in preservice elementary teachers who studied a laboratory unit on ecology. *Georgia Journal of Science*, 57(3), 210–223.

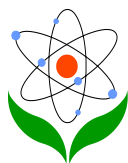

- Bischoff, P. J. (2006). The role of knowledge structures in the ability of preservice elementary teachers to diagnose a child's understanding of molecular kinetics. *Science Education*, 90(5), 936–951.
- Bischoff, P. J., & Anderson, O. R. (1998). A case study analysis of the development of knowledge schema, ideational networks, and higher cognitive operations among high school students who studied ecology. *School Science and Mathematics*, 54(5), 228–237.
- Bischoff, P. J., & Anderson, O. R. (2001). Development of knowledge frameworks and higher order cognitive operations among secondary school students who studied a unit on ecology. *Journal of Biological Education*, 35(2), 81–88.
- Bischoff, P. J., Avery, L., Golden, C. F., & French, P. (2010). An analysis of knowledge structure, diversity and diagnostic abilities among pre-service science teachers within the domain of oxidation and reduction chemistry. *Journal of Science Teacher Education*, 21(4), 411–429.
- Bodner, G. M. (1986). Constructivism: A theory of knowledge. *Journal of Chemical Education*, 63(10), 873–878.
- Bretz, S. L. (2001). Novak's theory of education: Human constructivism and meaningful learning. *Journal of Chemical Education*, 78(8), 1107.
- Burrows, N. L., & Mooring, S. R. (2015). Using concept mapping to uncover students' knowledge structures of chemical bonding concepts. *Chemistry Education Research and Practice*, 16, 53–66.
- Büyüköztürk, Ş., Kılıç Çakmak, E., Akgün, Ö. E., Karadeniz, Ş., & Demirel, F. (2013). *Bilimsel Araştırma Yöntemleri* (14.baskı). Ankara: Pegem Yayınları.
- Chang, C-Y., Yeh, T-K., & Barufaldi, J. P. (2010). The positive and negative effects of science concept tests on student conceptual understanding. *International Journal of Science Education*, 32(2), 265–282.
- Chin-Chung, T., & Chao-Ming, H. (2001). Development of cognitive structures and information processing strategies of elementary school students learning about biological reproduction. *Journal of Biological Education* 36(1), 21–26.
- Cracolice, M. S., Deming, J. C., & Ehlert, B. (2008). Concept learning versus problem solving: A cognitive difference. *Journal of Chemical Education*, 85(6), 873–878.
- Dhindsa, H. S., & Anderson, O. R. (2004). Using a conceptual-change approach to help preservice science teachers reorganize their knowledge structures for constructivist teaching. *Journal of Science Teacher Education* 15(1), 63–85.
- Fosnot, C. T. (1996). Constructivism: A psychological theory of learning. In C.T. Fosnot, (Ed.). *Constructivism: Theory, Perspectives and Practice* (pp. 3–7). New York: Teachers College Press.
- Gunstone, R. F. (1980). Word association and the description of cognitive structure. *Research in Science Education*, 10(1), 45–53.
- Howard, R. (1988). Schemata: Implications for teaching science. *Australian Science Teachers Journal*, 34, 29–34.
- Jonassen, D. H. (1987). Assessing cognitive structure: Verifying a method using pattern notes. *Journal of Research and Development in Education*, 20(3), 1–14.
- Karagöz Şahin, O. (2004). *Deneyimli kimya öğretmenlerinin ve ortaöğretim öğrencilerinin modern atom teorisi konusunda bilişsel yapılarının ortaya çıkarılması* (Yüksek lisans tezi, Balıkesir, Türkiye: Balıkesir Üniversitesi).
- Lavendowski, C. (1981). Epistemology of a physics laboratory on electricity and magnetism (Unpublished PhD dissertation, Ithaca, NY: Cornell University).

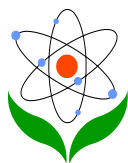

- Mason D. S., Shell, D. F., & Crawley, F. E. (1997). Differences in problem solving by nonscience majors in introductory chemistry on paired algorithmic-conceptual problems. *Journal of Research in Science Teaching*, 34(9), 905–923.
- Nakhleh, M. B. (1993). Are our students conceptual thinkers or algorithmic problem solvers? Identifying conceptual students in general chemistry. *Journal of Chemical Education*, 70(1), 52–55.
- Nakhleh M. B., & Mitchell, R. C. (1993). Concept learning versus problem solving: There is a difference. *Journal of Chemical Education*, 70(3), 190–192.
- Novak, J. D. (1977). An alternative to Piagetian psychology for sciences and mathematics education. *Science Education*, 61(4), 453–477.
- Novak, J. D., & Gowin, D. B. (1984). *Learning How to Learn*. New York: Cambridge University Press.
- Novak, J. D., Gowin, D. B., & Johansen, G. T. (1983). The use of concept mapping and knowledge mapping with junior high school science students. *Science Education*, 67(5), 625–645.
- Oskay, Ö. Ö., & Dinçol, S. (2011). The effects of internet-assisted chemistry applications on prospective chemistry teachers' cognitive structure. *Procedia Social and Behavioral Sciences*, 15, 927–931.
- Oskay, Ö. Ö., Temel, S., Özgür, S. D., & Erdem, E. (2012). Determination of preservice chemistry teachers' cognitive structures via flow map method and their knowledge level on “greenhouse gases and their effects” topic. *Eurasian Journal of Physics & Chemistry Education*, 4(1), 30–45.
- Pendley, B. D., Bretz, R. L., & Novak, J. D. (1994). Concept map as a tool to assess learning in chemistry. *Journal of Chemical Education*, 71(1), 9–15.
- Pickering, M. (1990). Further studies on concept learning versus problem solving. *Journal of Chemical Education*, 67(3), 254–255.
- Sawrey, B. A. (1990). Concept learning versus problem solving: Revisited. *Journal of Chemical Education*, 67(3), 253–254.
- Selvi, M., & Yakışan, M. (2005). Akış haritaları yoluyla öğrencilerin bilişsel yapılarının belirlenmesi: Ekolojik döngüler. *Türk Fen Eğitimi Dergisi*, 2(1), 46–55.
- Shavelson, R. J. (1972). Some aspects of the correspondence between content structure and cognitive structure in physics education. *Journal of Educational Psychology*, 63(3), 225–234.
- Shavelson, R. J. (1974). Methods for examining representations of a subject matter structure in a student's memory. *Journal of Research in Science Teaching*, 11, 231–249.
- Snow, R. E. (1989). Toward assessment of cognitive and conative structures in learning. *Educational Research*, 18(9), 8–14.
- Temel, S., & Özcan, Ö. (2016). The analysis of prospective chemistry teachers' cognitive structure: the subject of covalent and ionic bonding. *Eurasia Journal of Mathematics Science and Technology Education*, 12(8), 1953-1969.
- Tsai, C. C. (1998). An analysis of Taiwanese eighth graders' science achievement, scientific epistemological beliefs and cognitive structure outcomes after learning basic atomic theory. *International Journal of Science Education*, 20(4), 413–425.
- Tsai, C. C. (2000). The effects of STS-oriented instruction on female tenth graders' cognitive structure outcomes and the role of student scientific epistemological beliefs. *International Journal of Science Education*, 22(10), 1099–1115.

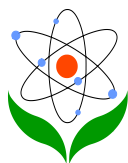

- Tsai, C. C. (2001). Probing students' cognitive structures in science: The use of a flow map method coupled with a meta-listening technique. *Studies in Educational Evaluation*, 27(3), 257–268.
- Tsai, C. C., & Huang, C. M. (2001). Development of cognitive structures and information processing strategies of elementary school students learning about biological reproduction. *Journal of Biological Education*, 36(1), 21–26.
- Tsai, C. C., & Huang, C. M. (2002). Exploring students' cognitive structure in learning science: A review of relevant methods. *Journal of Biological Education*, 36(4), 163–169.
- Valanides, N., Nicolaidou, A., & Eilks, I. (2003). Twelfth grade students' understanding of oxidation and combustion: Using action research to improve teachers' practical knowledge and teaching practice. *Research in Science & Technological Education*, 21(2), 59–175.
- Zhou, Q., Wang, T., & Zheng, Q. (2015). Probing high school students' cognitive structures and key areas of learning difficulties on ethanoic acid using a flow map method. *Chemistry Education Research Practice*, 16, 589–602.